

Fig. 1A

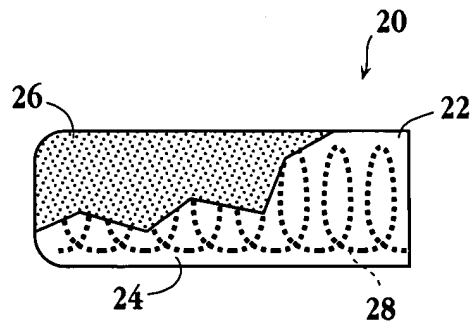

Fig. 1B

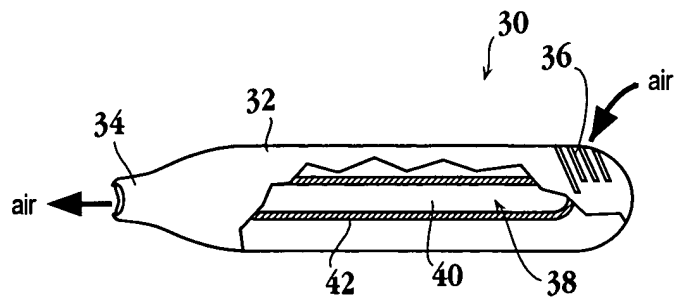
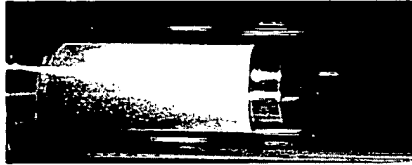

Fig. 2A

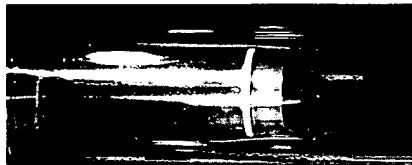

Fig. 3A



$t = 0$ ms

Fig. 3B



$t = 50$ ms

Fig. 3C



$t = 100$ ms

Fig. 3D



$t = 200$ ms

Fig. 3E



$t = 500$ ms

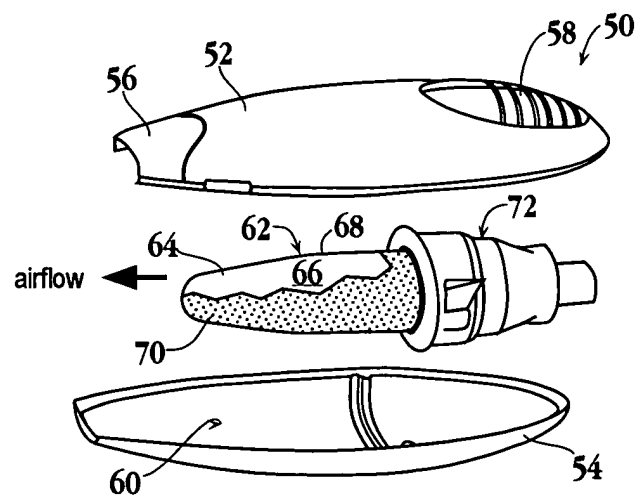

Fig. 2B

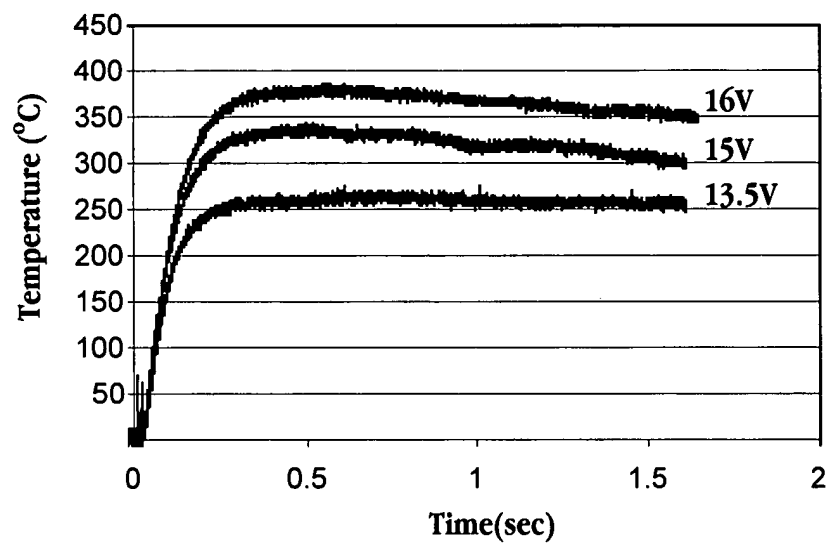

Fig. 4A

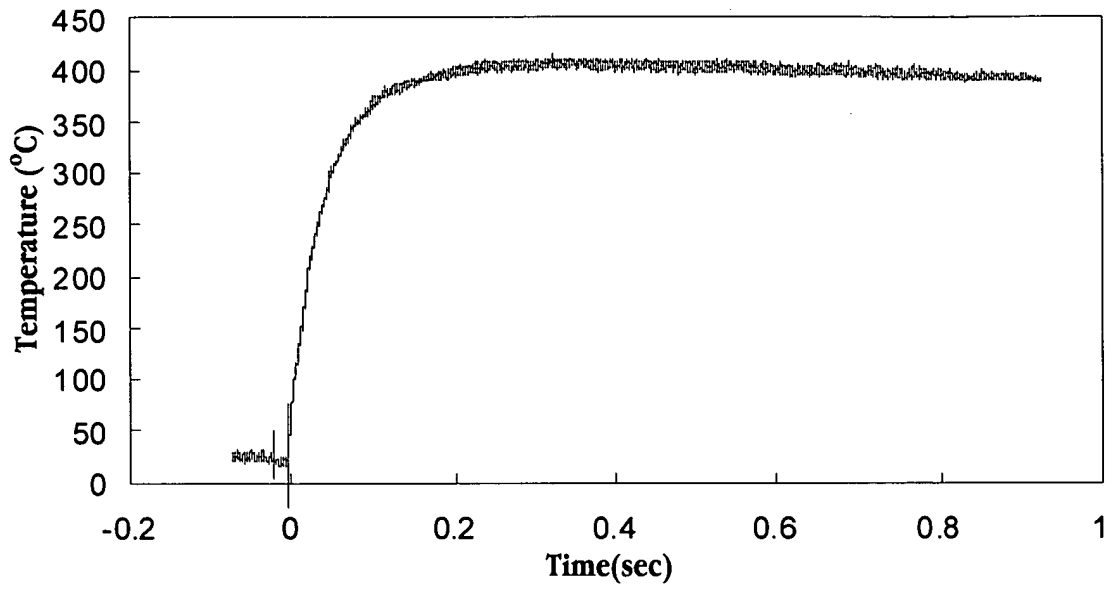

Fig. 4B

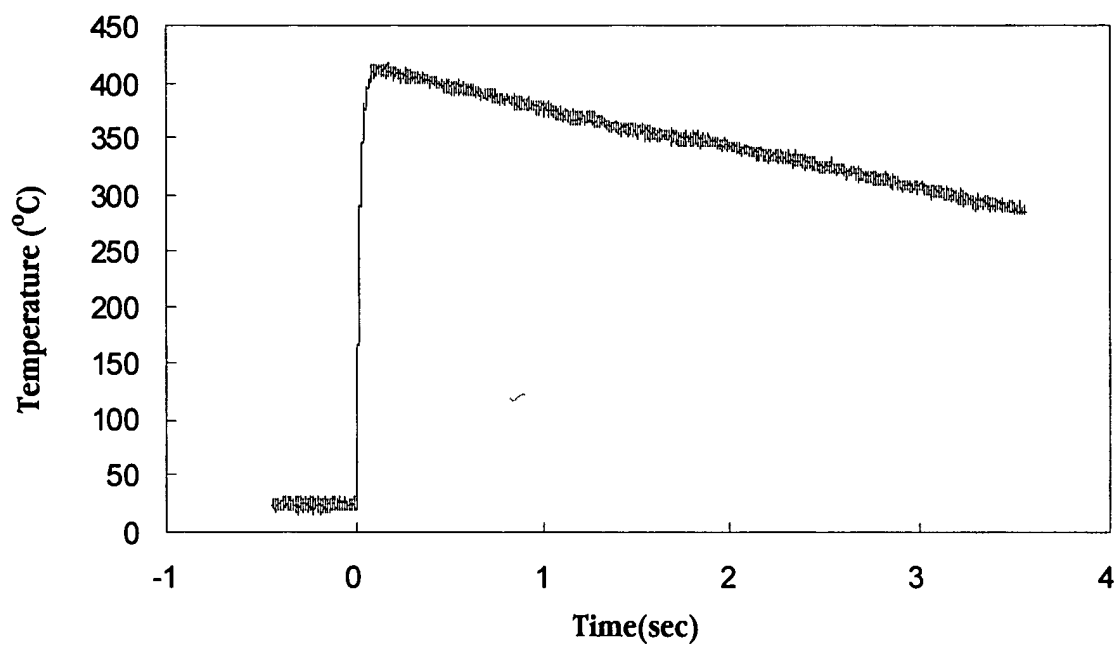

Fig. 5A

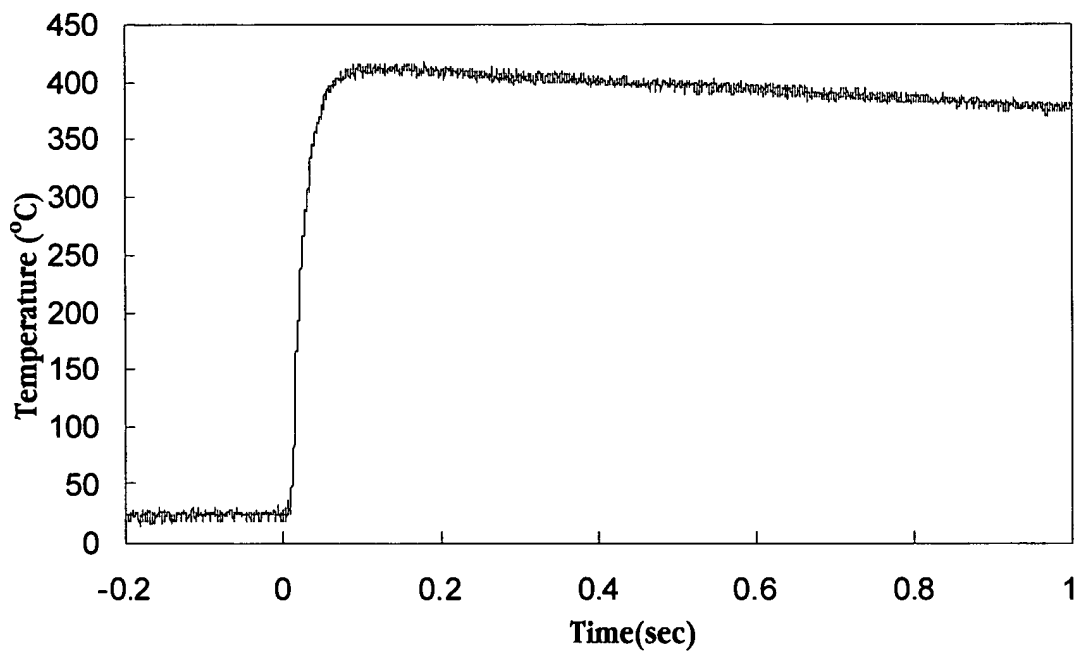

Fig. 5B

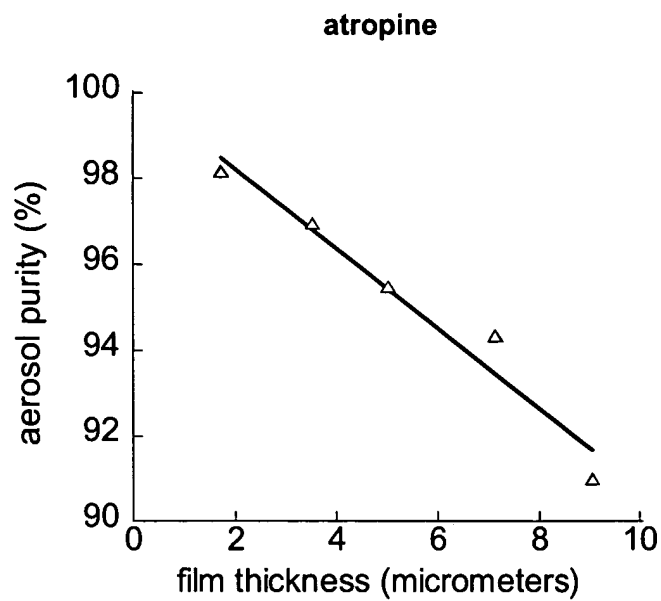

Fig. 6

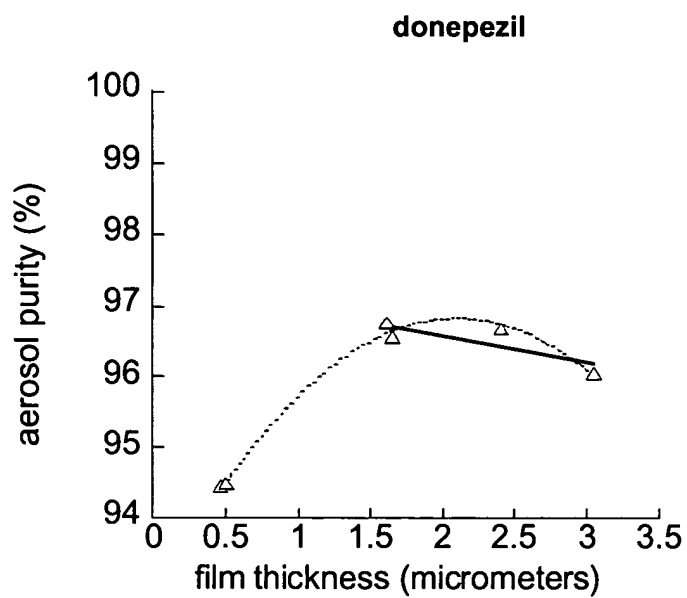

Fig. 7

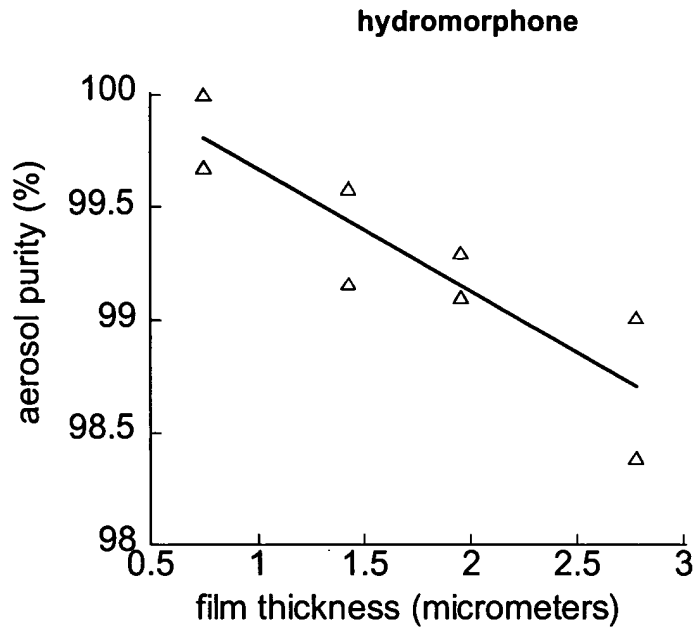

Fig. 8

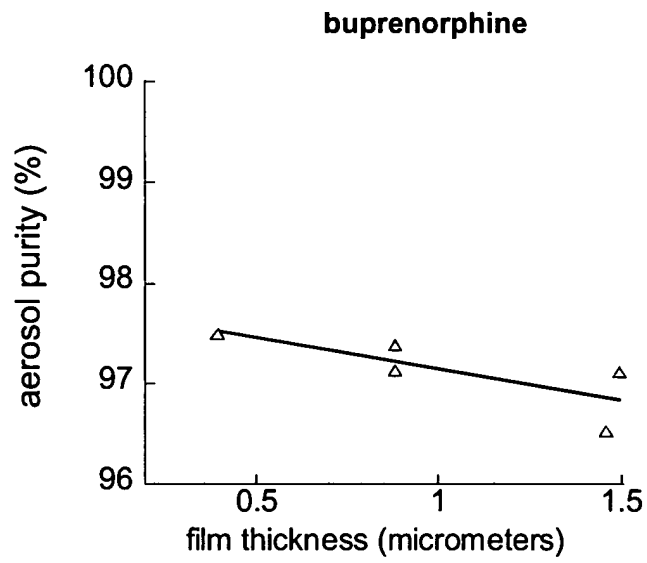

Fig. 9

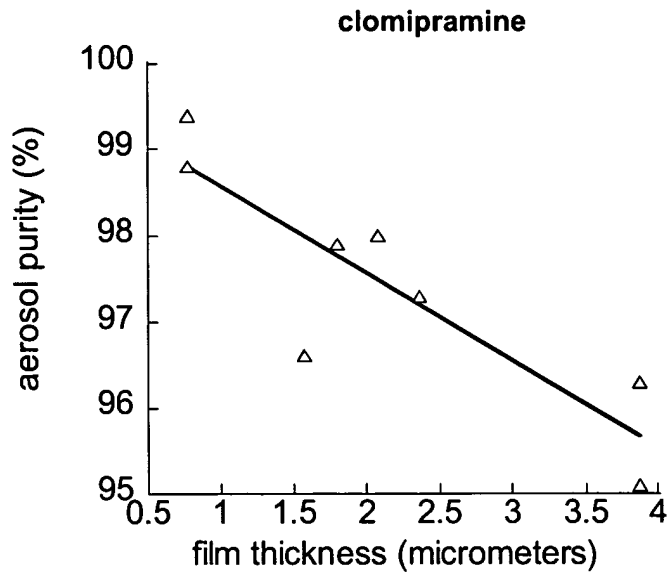

Fig. 10

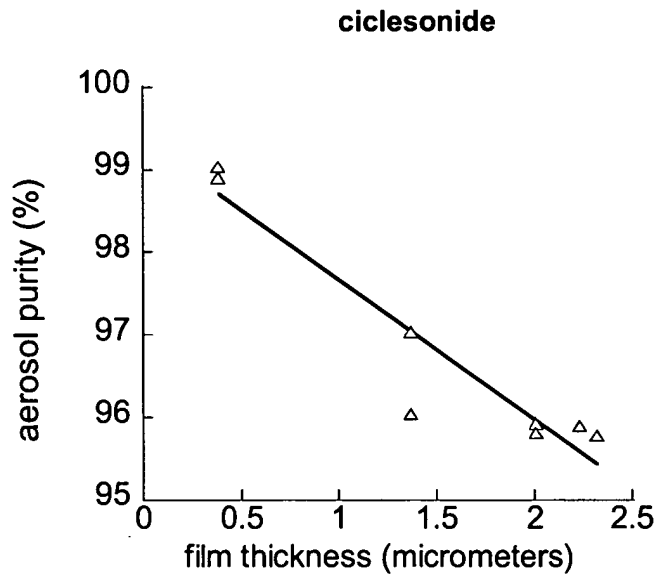

Fig. 11

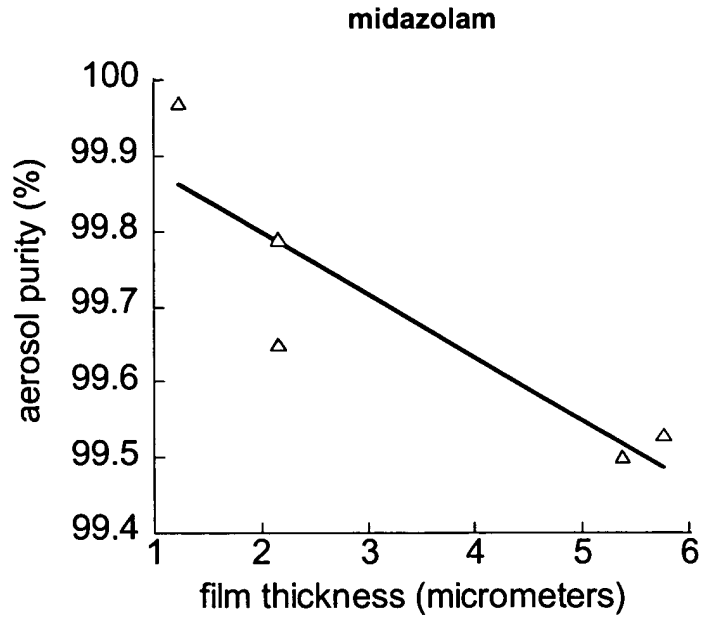

Fig. 12

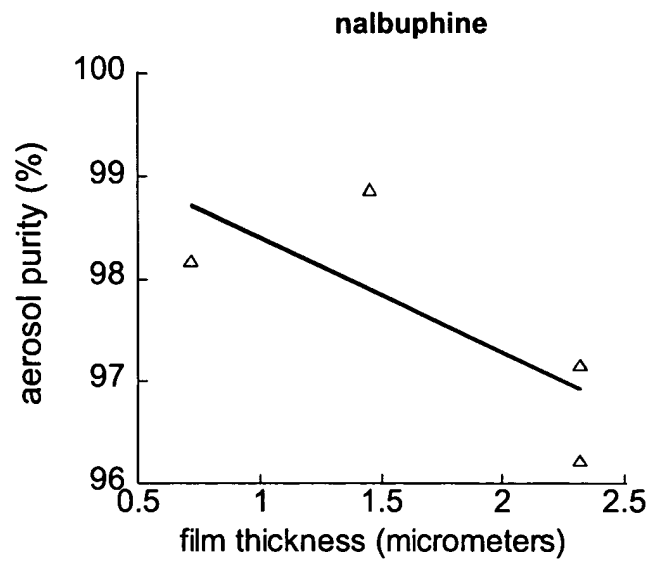

Fig. 13

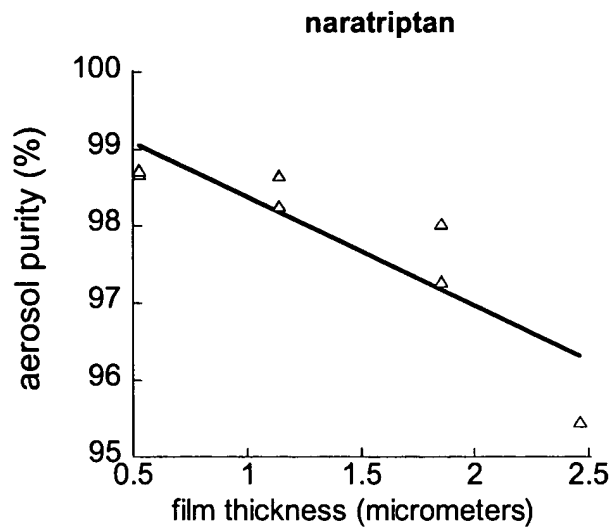

Fig. 14

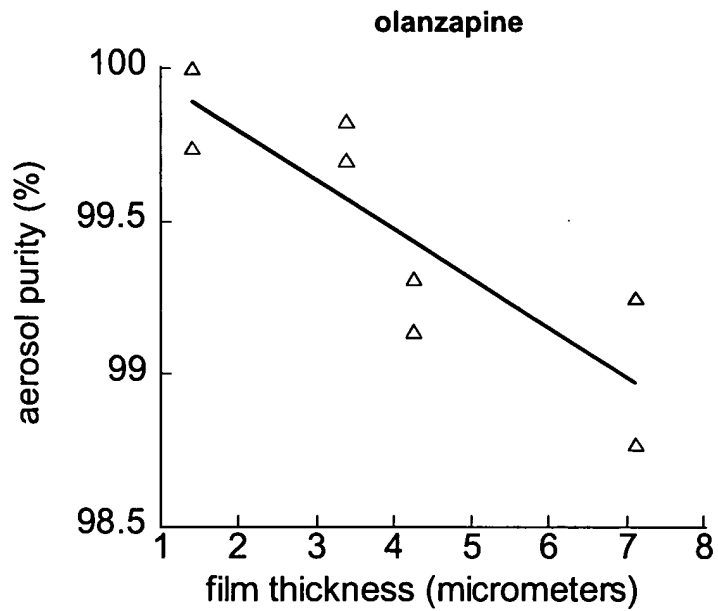

Fig. 15

quetiapine

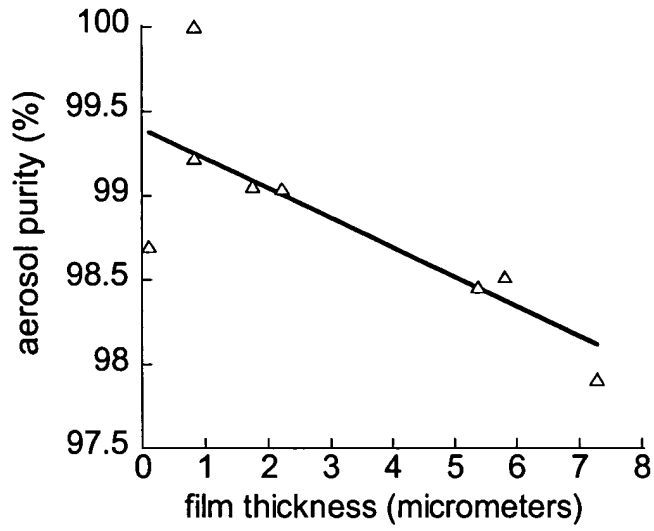

Fig. 16

tadalafil

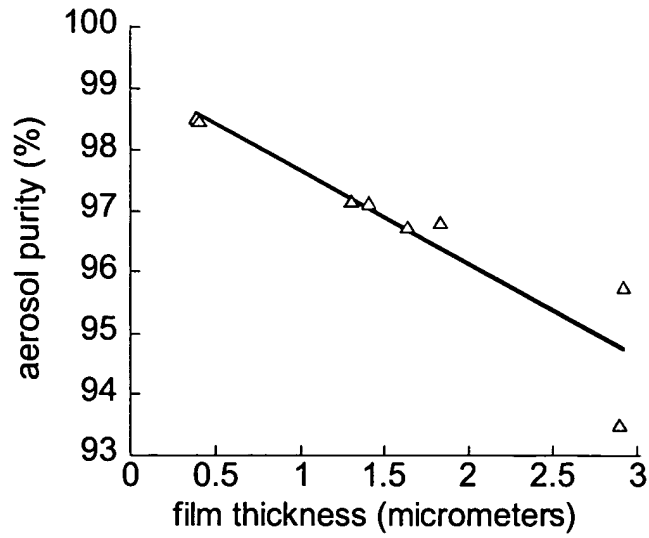

Fig. 17

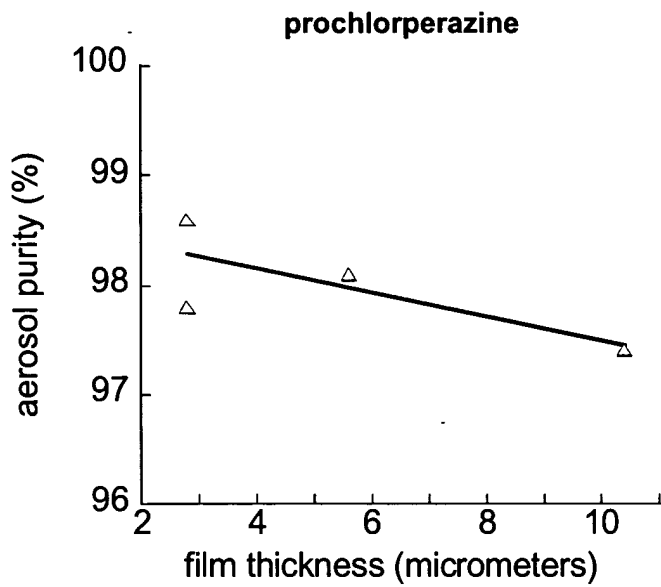

Fig. 18

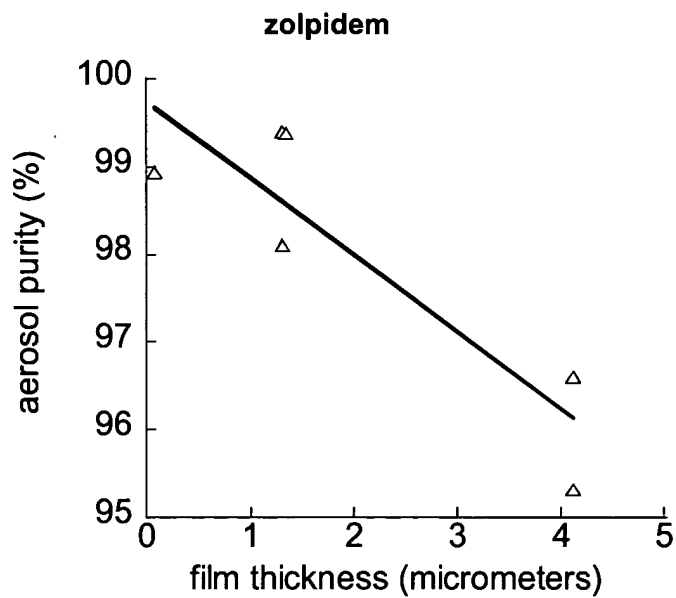

Fig. 19

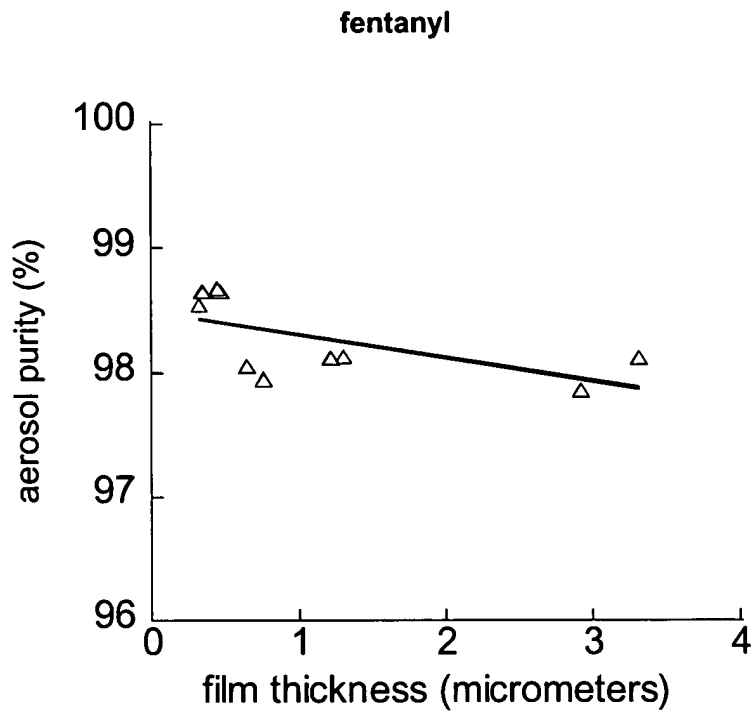

Fig. 20

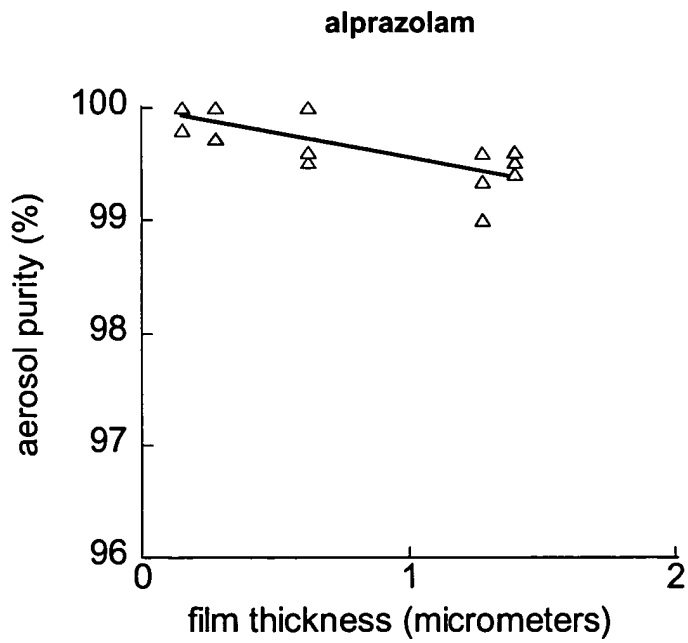

Fig. 21

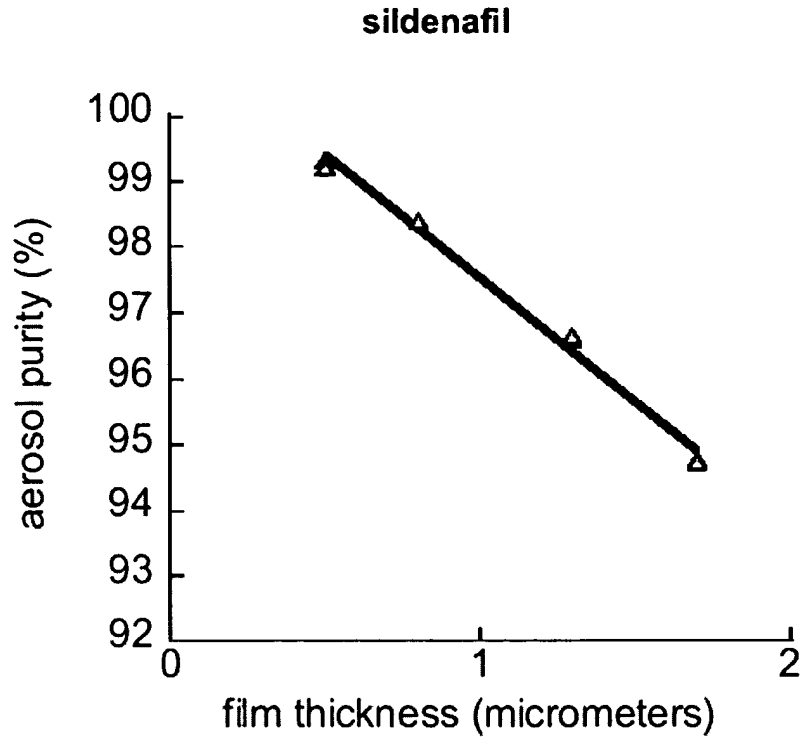

Fig. 22

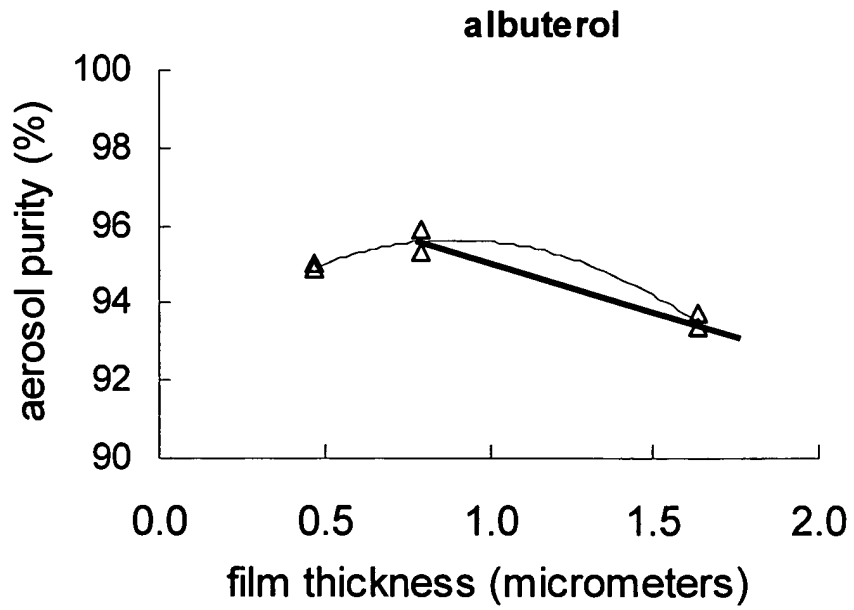
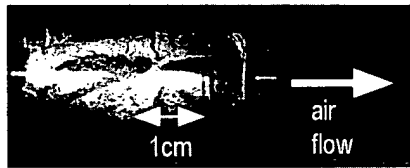

Fig. 23

Fig. 24A



$t=0$ msec

Fig. 24B



$t=50$ msec

Fig. 24C

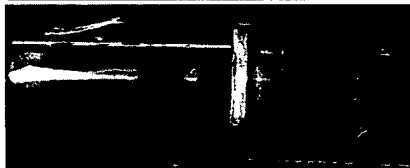

$t=100$ msec

Fig. 24D

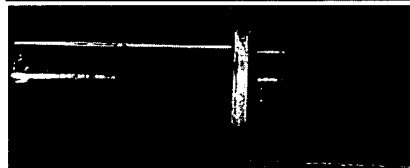

$t=200$ msec

Fig. 25A

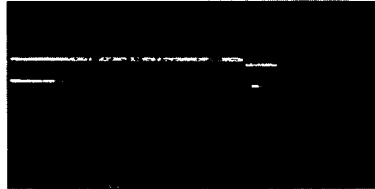

$t=0$ msec

Fig. 25B

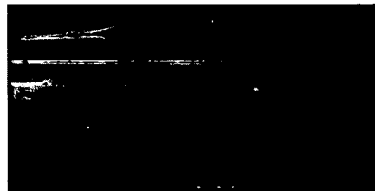

$t=50$ msec

Fig. 25C

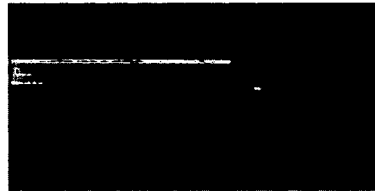

$t=100$ msec

Fig. 25D

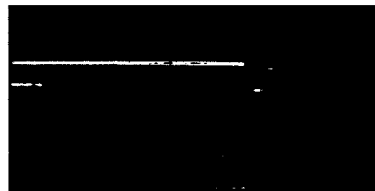

$t=200$ msec

Fig. 26A

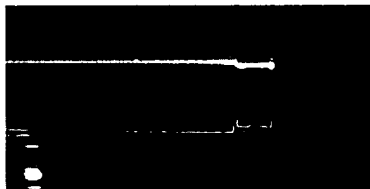

$t=0$ msec

Fig. 26B

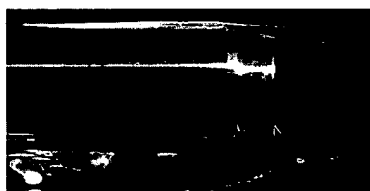

$t=50$ msec

Fig. 26C

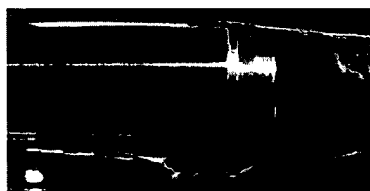

$t=100$ msec

Fig. 26D

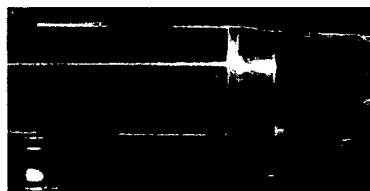

$t=200$ msec

Fig. 26E

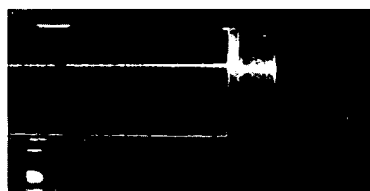

$t=300$ msec

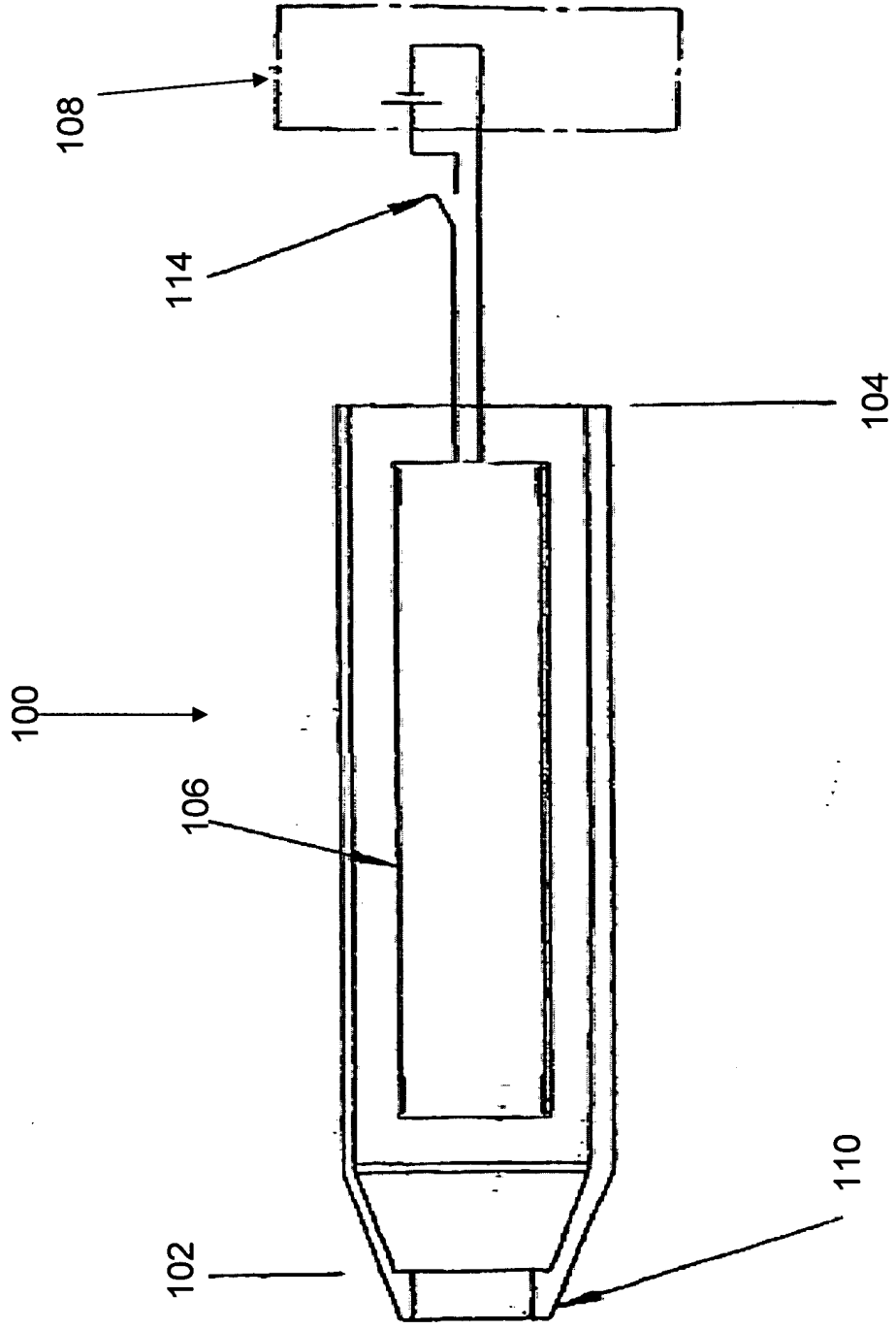

Fig. 27